

We Cable Accessories India are a leading and distinguished Manufacturer, Exporter, Supplier, Retailer, Importer, Service Provider and Distributor of quality ADSS Optical Fiber, Aerial Bunched Cables, Brass & Copper Products, Cables and Wire Accessories and Clamps.

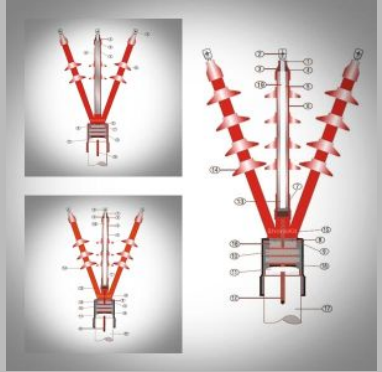

Heat Shrinkable Outdoor Terminations Kit

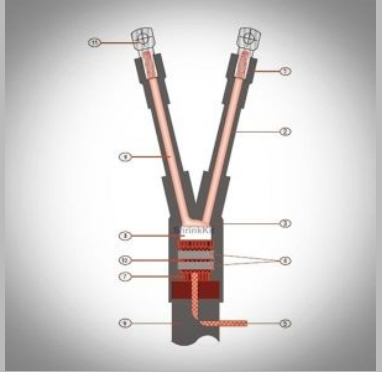

Heat Shrinkable Low Voltage Terminations Kit



Low Voltage Cables



Terminal Ferrules



Terminal Lugs



Cast Resin Joints Kit



## About Cable Accessories India

Cable accessories india established in the year 2013 entered the business of cable management products with specialization in the field of electrical cable accessories range of products. Cable accessories india stands as leader in indian and overseas market. since 2013 we have managed to establish ourselves as an eminent supplier and exporter of a wide range of electricals switchgears and accessories adaptable to all types of domestic industrial and commercial usage. We are one of the leading manufacturers and exporters of high quality products like: main products: \* electrical power cable accessories \* cable joints and terminations kit \* heat shrinkable cable jointing kits & end terminations kits \* cast resin straight through jointing kits \* electrical cables \* armoured copper cables \* single core copper cables \* xlpe cables \* aerial bunched cable (abc cables) \* cable terminal connectors \* earthing electrode system \* cable accessories \* electrical control panel accessories \* heat shrinkable accessories

### Other Info:

Product Satisfaction : ISO 9001 2015 Certified Co

## Factsheet

### Basic Information

Nature of Business : Manufacturer / Exporter / Supplier / Retailer / Importer / Service Provider / Distributor

Contact Person : Vinod Kumar

Registered Address : # 31, Near Govt. High School, Old Hamida,, Yamunanagar, Haryana

Total Number of Employees : Below 20

Year of Establishment : 2013

Legal Status of Firm : Individual (Sole proprietorship)

### Cables and Wire Accessories



Tinned Copper Braid



Solderless Earth Spring Kits For 3 Core XLPE Cables



Solderless Earth Connection Kits For Pilc Cables Outdoor

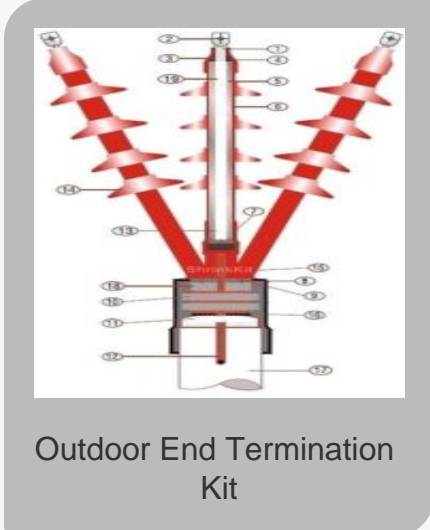

Outdoor End Termination Kit

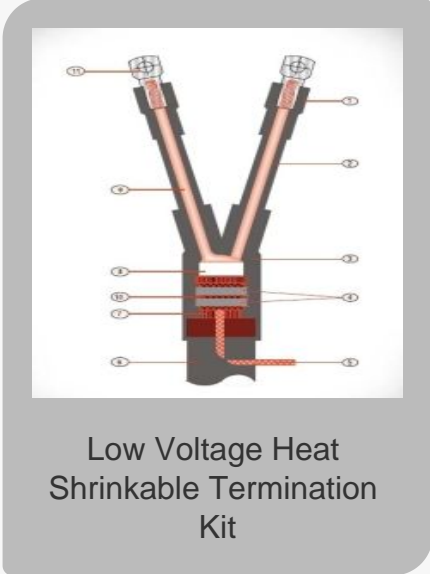

Low Voltage Heat Shrinkable Termination Kit



Heatshrink Inline Joints For Single Core PILC Cables

**Wire Accessories**

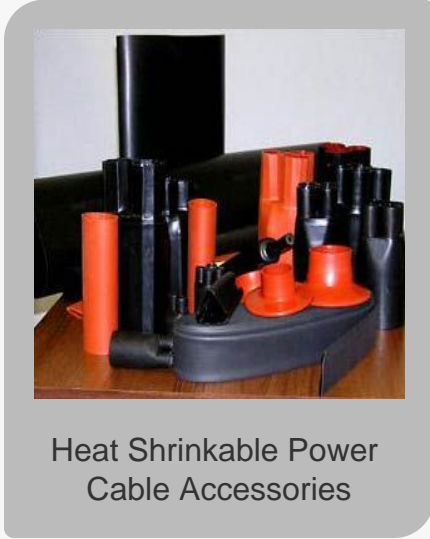

Heat Shrinkable Power Cable Accessories



Heat Shrinkable Cable Accessories



GI Wire Mesh Cable Jointing Accessories

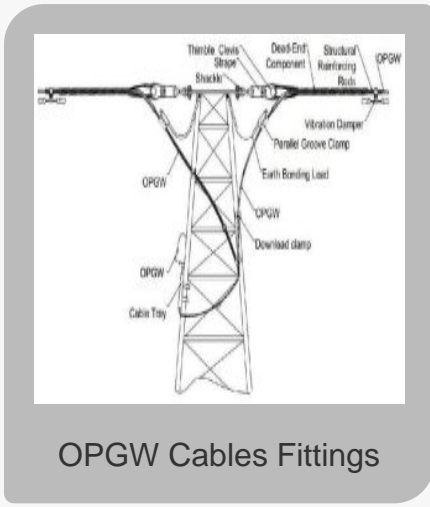

OPGW Cables Fittings

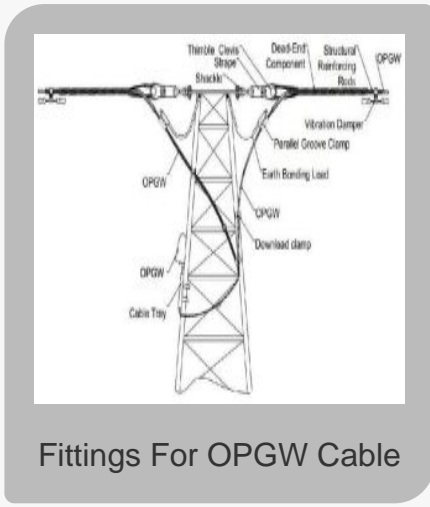

Fittings For OPGW Cable

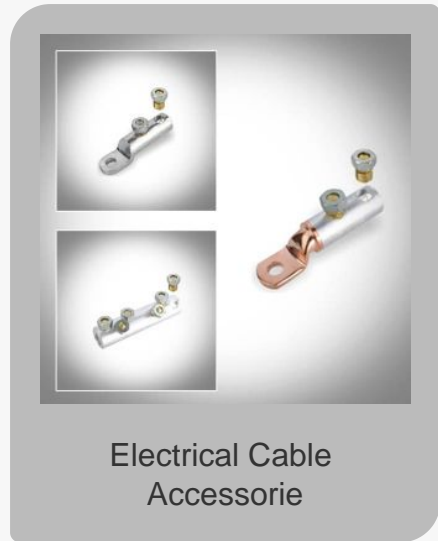

Electrical Cable Accessorie

Electrical Cables & Wires

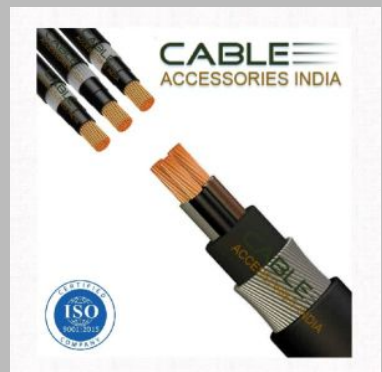

Three Core To 3 Single Core Heat Shrinkable Trifurcating MV Cable Joints



Terminal Lugs



Crimping Type Terminal Lugs

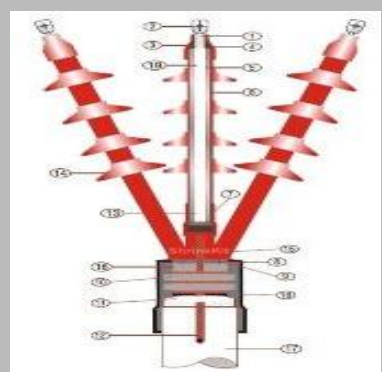

Cables & AMP; Cable Jointing Kits

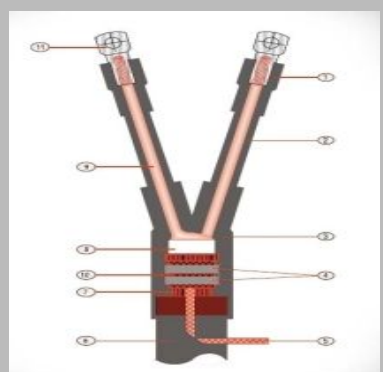

Cable Terminations

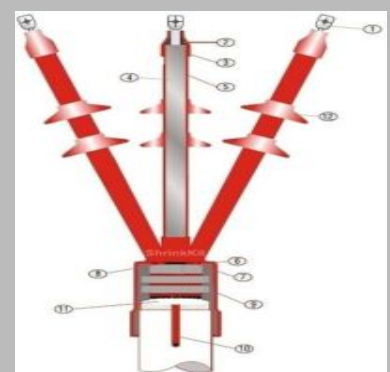

Cable Termination

## Tapes



Self Amalgamating Tape



Heat Shrinkable Busbar  
Insulation Tapes



Heat Shrinkable Busbar  
Insulation Tape



EPR Self Amalgamating  
Tapes



Copper Mesh Tape

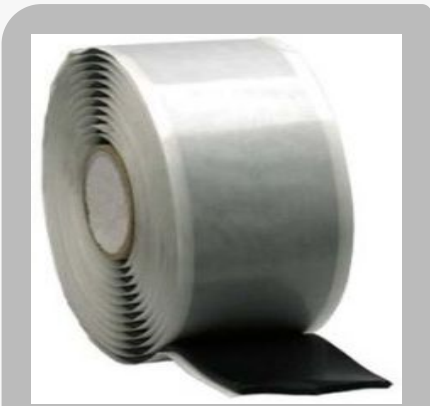

Black Mastic Sealing  
Tape

## Earthing Equipment



Earthing Electrode System



Cable Armour Earthing Arrangement Kits



Armour Earthing Kit For Single Core Armoured XLPE Cables



Armour Earthing Kit For Three Core Armoured XLPE Cables



Armour Earthing Kit For Three Core Armoured XLPE Cables

## Power Cables



XLPE Cables



Power Cables

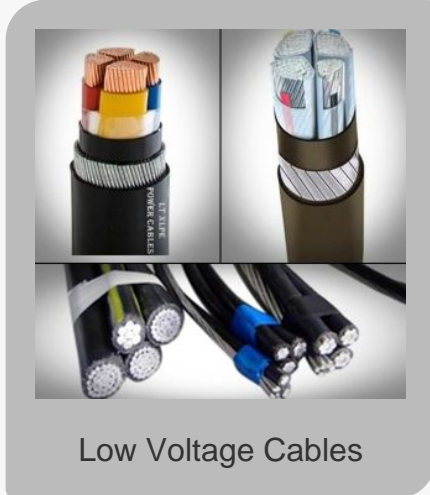

Low Voltage Cables



Heat Shrinkable Outdoor  
XLPE Cable



## Hardware Fittings and Accessories

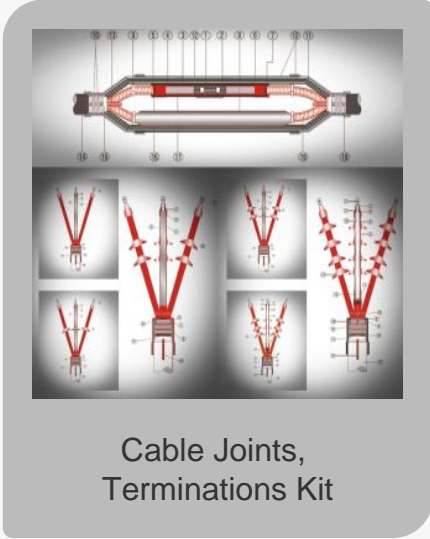

Other Products/Services

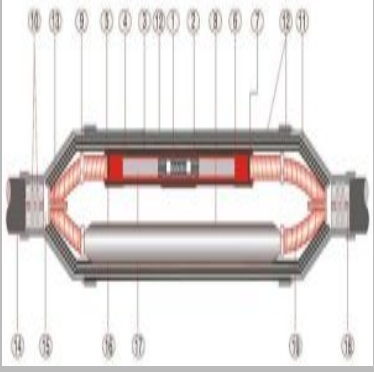

12KV STRAIGHT JOINT KIT



Cable Armour Earthing Arrangement



Cold Shrink Joint Kit



Cold Shrink Termination Kit



Copper Mesh Kit



Heat Shrinkable Breakouts

Other Products/Services

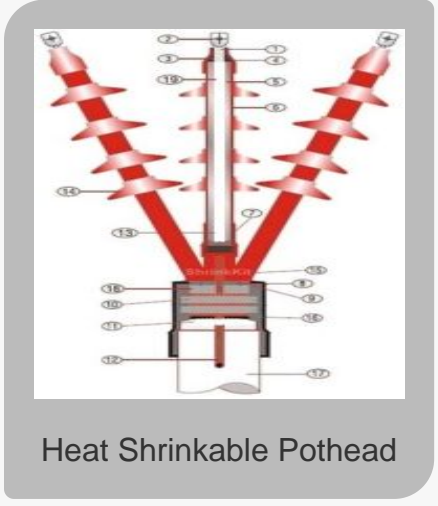

Heat Shrinkable Pothead



Heat Shrinkable Straight Boots

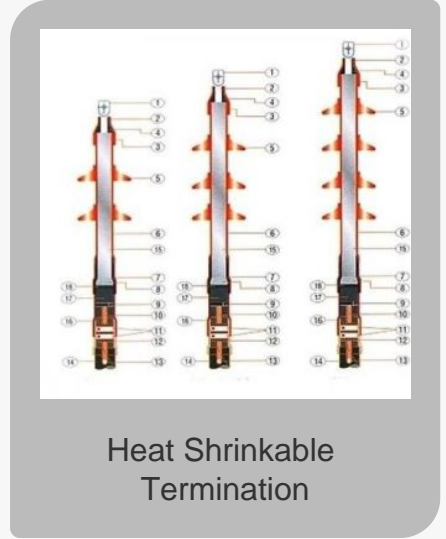

Heat Shrinkable Termination

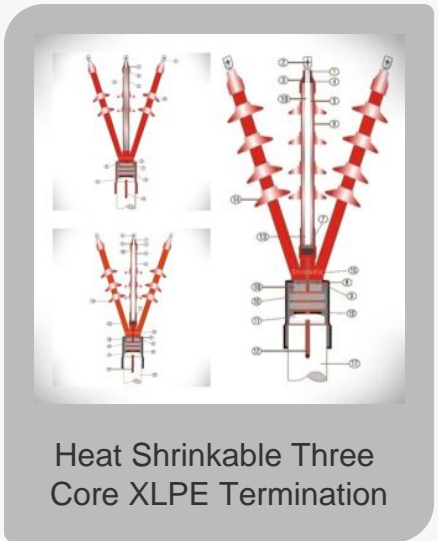

Heat Shrinkable Three Core XLPE Termination

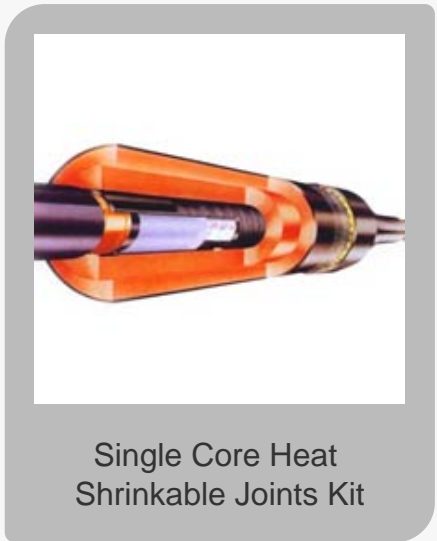

Single Core Heat Shrinkable Joints Kit

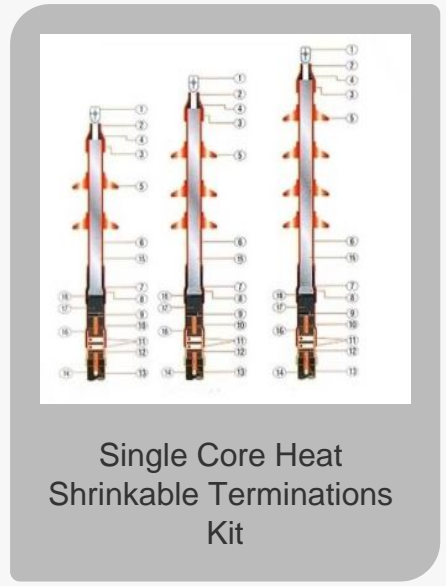

Single Core Heat Shrinkable Terminations Kit



**Other Products/Services**



## Contact Us

### Cable Accessories India

Contact Person : Vinod Kumar

 # 31, Near Govt. High School, Old Hamida,

 08048117137

 cableaccessories@mail.com

 <https://www.exportersindia.com/cableaccessoriesindia>